

USER'S MANUAL

WINDOW/WALL-TYPE ROOM AIR CONDITIONER

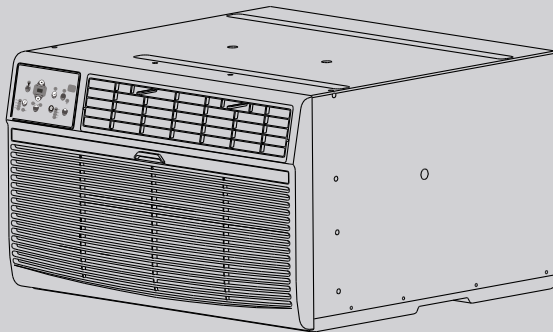

MULTI-STEP SPEED ELECTRONIC CONTROL

TABLE OF CONTENTS

Important Safety Instructions	1-3	Normal Sounds	18
Installation Instructions	4-17	Air Conditioner Features	18-20
		Care and Cleaning	20-21
		Troubleshooting Tip	21-22





**Before using your air conditioner, please read
this manual carefully and keep it for future reference.**

IMPORTANT SAFETY INSTRUCTIONS

















READ THIS MANUAL

Inside you will find many helpful hints on how to use and maintain your air conditioner properly. Just a little preventive care on your part can save you a great deal of time and money over the life of your air conditioner. You'll find many answers to common problems in the chart of troubleshooting tips. If you review our chart of Troubleshooting Tips first, you may not need to call for service at all.

To prevent injury to the user or other people and property damage, the following instructions must be followed. Incorrect operation due to ignoring of instructions may cause harm or damage. The seriousness is classified by the following indications.

 WARNING	This symbol indicates the possibility of death or serious injury.		
 CAUTION	This symbol indicates the possibility of injury or damage to property.		
	Never do this.		Always do this.

WARNING

<p> Plug in power plug properly.</p> <ul style="list-style-type: none"> ● Otherwise, it may cause electric shock or fire due to excess heat generation. 	<p> Do not operate or stop the unit by inserting or pulling out the power plug.</p> <ul style="list-style-type: none"> ● It may cause electric shock or fire due to heat generation. 	<p> Do not damage or use an unspecified power cord.</p> <ul style="list-style-type: none"> ● It may cause electric shock or fire. ● If the power cord is damaged, it must be replaced by the manufacturer or an authorised service centre or a similarly qualified person in order to avoid a hazard.
<p> Always install circuit breaker and a dedicated power circuit.</p> <ul style="list-style-type: none"> ● Incorrect installation may cause fire and electric shock. 	<p> Do not operate with wet hands or in damp environment.</p> <ul style="list-style-type: none"> ● It may cause electric shock. 	<p> Do not direct airflow at room occupants only.</p> <ul style="list-style-type: none"> ● This could damage your health.
<p> Always ensure effective grounding.</p> <ul style="list-style-type: none"> ● Incorrect grounding may cause electric shock. 	<p> Do not allow water to run into electric parts.</p> <ul style="list-style-type: none"> ● It may cause failure of machine or electric shock. 	<p> Do not modify power cord length or share the outlet with other appliances.</p> <ul style="list-style-type: none"> ● It may cause electric shock or fire due to heat generation.
<p> Unplug the unit if strange sounds, smell, or smoke comes from it.</p> <ul style="list-style-type: none"> ● It may cause fire and electric shock. 	<p> Do not use the socket if it is loose or damaged.</p> <ul style="list-style-type: none"> ● It may cause fire and electric shock. 	<p> Do not open the unit during operation.</p> <ul style="list-style-type: none"> ● It may cause electric shock.
<p> Keep firearms away.</p> <ul style="list-style-type: none"> ● It may cause fire. 	<p> Do not use the power cord close to heating appliances.</p> <ul style="list-style-type: none"> ● It may cause fire and electric shock. 	<p> Do not use the power cord near flammable gas or combustibles, such as gasoline, benzene, thinner, etc.</p> <ul style="list-style-type: none"> ● It may cause an explosion or fire.
<p> Ventilate room before operating air conditioner if there is a gas leakage from another appliance.</p> <ul style="list-style-type: none"> ● It may cause explosion, fire and, burns. 	<p> Do not disassemble or modify unit.</p> <ul style="list-style-type: none"> ● It may cause failure and electric shock. 	

IMPORTANT SAFETY INSTRUCTIONS

CAUTION

- | | | |
|---|--|--|
| <ul style="list-style-type: none"> ⊘ When the air filter is to be removed, do not touch the metal parts of the unit. ● It may cause an injury. | <ul style="list-style-type: none"> ⊘ Do not put a pet or house plant where it will be exposed to direct air flow. ● This could injure the pet or plant. | <ul style="list-style-type: none"> ⊘ Ventilate the room well when used together with a stove, etc. ● An oxygen shortage may occur. |
| <ul style="list-style-type: none"> ⊘ Do not use strong detergent such as wax or thinner but use a soft cloth. ● Appearance may be deteriorated due to change of product color or scratching of its surface. | <ul style="list-style-type: none"> ⊘ Do not clean the air conditioner with water. ● Water may enter the unit and degrade the insulation. It may cause an electric shock. | <ul style="list-style-type: none"> ⊘ Do not use for special purposes. ● Do not use this air conditioner to preserve precision devices, food, pets, plants, and art objects. It may cause deterioration of quality, etc. |
| <ul style="list-style-type: none"> ⊘ Stop operation and close the window in storm or hurricane. ● Operation with windows opened may cause wetting of indoor and soaking of household furniture. | <ul style="list-style-type: none"> ⊘ When the unit is to be cleaned, switch off, and turn off the circuit breaker. ● Do not clean unit when power is on as it may cause fire and electric shock, it may cause an injury. | <ul style="list-style-type: none"> ⊘ Ensure that the installation bracket of the outdoor appliance is not damaged due to prolonged exposure. ● If bracket is damaged, there is concern of damage due to falling of unit. |
| <ul style="list-style-type: none"> ⊘ Always insert the filters securely. Clean filter once every two weeks. ● Operation without filters may cause failure. | <ul style="list-style-type: none"> ⊘ Hold the plug by the head of the power plug when taking it out. ● It may cause electric shock and damage. | <ul style="list-style-type: none"> ⊘ Turn off the main power switch when not using the unit for a long time. ● It may cause failure of product or fire. |
| <ul style="list-style-type: none"> ⊘ Do not place obstacles around air-inlets or inside of air-outlet. ● It may cause failure of appliance or accident. | <ul style="list-style-type: none"> ⊘ Do not place heavy object on the power cord and ensure that the cord is not compressed. ● There is danger of fire or electric shock. | <ul style="list-style-type: none"> ⊘ Do not drink water drained from air conditioner. ● It contains contaminants and could make you sick. |
| <ul style="list-style-type: none"> ⊘ Use caution when unpacking and installing. Sharp edges could cause injury. | <ul style="list-style-type: none"> ⊘ If water enters the unit, turn the unit off at the power outlet and switch off the circuit breaker. Isolate supply by taking the power-plug out and contact a qualified service technician. | |

CAUTION

- This appliance is not intended for use by persons (including children) with reduced physical, sensory or mental capabilities or lack of experience and knowledge, unless they have been given supervision or instruction concerning use of the appliance by a person responsible for their safety.
- Children should be supervised to ensure that they do not play with the appliance.
- If the supply cord is damaged, it must be replaced by the manufacturer, its service agent or similarly qualified persons in order to avoid a hazard.
- The appliance shall be installed in accordance with national wiring regulations.
- Do not operate your air conditioner in a wet room such as a bathroom or laundry room.
- The appliance with electric heater shall have at least 1 meter space to the combustible materials.
- Contact the authorised service technician for repair or maintenance of this unit.
- Contact the authorised installer for installation of this unit.

IMPORTANT SAFETY INSTRUCTIONS

NOTE:

The power supply cord with this air conditioner contains a current detection device designed to reduce the risk of fire. Please refer to the section Operation of Current Device for details. In the event that the power supply cord is damaged, it cannot be repaired-it must be replaced with a cord from the Product Manufacturer.

WARNING

Avoid fire hazard or electric shock. Do not use an extension cord or an adaptor plug. Do not remove any prong from the power cord.

Grounding type wall receptacle

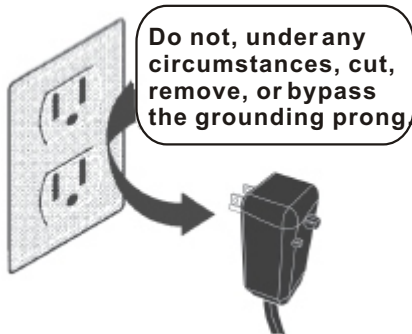

Power supply cord with 3-prong grounding plug and current detection device

WARNING

For Your Safety

Do not store or use gasoline or other flammable vapors and liquids in the vicinity of this or any other appliance.

WARNING

Prevent Accidents

To reduce the risk of fire, electrical shock, or injury to persons when using your air conditioner, follow basic precautions, including the following:

- Be sure the electrical service is adequate for the model you have chosen. This information can be found on the serial plate, which is located on the side of the cabinet and behind the grille.
- If the air conditioner is to be installed in a window, you will probably want to clean both sides of the glass first. If the window is a triple-track type with a screen panel included, remove the screen completely before installation.
- Be sure the air conditioner has been securely and correctly installed according to the installation instructions in this manual. Save this manual for possible future use in removing or installing this unit.
- When handling the air conditioner, be careful to avoid cuts from sharp metal fins on front and rear coils.

WARNING

Electrical Information

The complete electrical rating of your new room air conditioner is stated on the serial plate. Refer to the rating when checking the electrical requirements.

- Be sure the air conditioner is properly grounded. To minimize shock and fire hazards, proper grounding is important. The power cord is equipped with a three-prong grounding plug for protection against shock hazards.
- Your air conditioner must be used in a properly grounded wall receptacle. If the wall receptacle you intend to use is not adequately grounded or protected by a time delay fuse or circuit breaker, have a qualified electrician install the proper receptacle. Ensure the receptacle is accessible after the unit installation.
- Do not run air conditioner without side protective cover in place. This could result in mechanical damage within the air conditioner.
- **Do not use an extension cord or an adaptor plug.**

Operation of Current Device

(Applicable to the unit adopts current detection device only)

The power supply cord contains a current device that senses damage to the power cord. To test your power supply cord do the following:

1. Plug in the Air Conditioner.
2. The power supply cord will have TWO buttons on the plug head. Press the TEST button, you will notice a click as the RESET button pops out.
3. Press the RESET button, again you will notice a click as the button engages.
4. The power supply cord is now supplying electricity to the unit. (On some products this is also indicated by a light on the plug head.)

NOTE:

- Do not use this device to turn the unit on or off.
- Always make sure the RESET button is pushed in for correct operation.
- The power supply must be replaced if it fails reset when either the TEST button is pushed, or it cannot be reset. A new one can be obtained from the product manufacturer.
- If power supply cord is damaged, it cannot be repaired. It MUST be replaced by one obtained from the product manufacturer.

NOTE: This air conditioner is designed to be operated under condition as follows:

Cooling operation	Outdoor temp:	64-109°F/18-43°C (64-125°F/18-52°C for special tropical models)
	Indoor temp:	62-90°F/17-32°C
Heating operation	Outdoor temp:	23-76°F/-5-24°C
	Indoor temp:	32-80°F/0-27°C

Note: Performance may be reduced outside of these operating temperatures.

INSTALLATION INSTRUCTIONS



BEFORE YOU BEGIN

Read these instructions completely and carefully.

IMPORTANT- Save these instructions for local inspector's use.

IMPORTANT- Observe all governing codes and ordinances.

Note to Installer- Be sure to leave these instructions with the Consumer.

Note to Consumer- Keep these instructions for future reference.

Skill level- Installation of this appliance requires basic mechanical skills.

Completion time- Approximately 1 hour.

We recommend that two people install this product.

Proper installation is the responsibility of the installer.

Product failure due to improper installation is not covered under the Warranty.

You **MUST** use all supplied parts and use proper installation procedures as described in these instructions when installing this air conditioner.



CAUTION

Do not, under any circumstances, cut or remove the third (ground) prong from the power cord.

Do not change the plug on the power cord of the air conditioner.

Aluminum house wiring may present special problems- consult a qualified electrician.

When handling unit, be careful to avoid cuts from sharp metal edges and aluminum fins on front and rear coils.

Do This First (for existing sleeve)

Note that the air conditioner dimensions are: 24 inches wide, 14 inches high, and 18 inches deep (without front). Install Air Conditioner according to these installation instructions to achieve the best performance. Save these installation instructions for future reference.

NOTE: Do not use any screws other than those specified here.

Items in Kit

You may not need all parts in the kit. Discard unused parts.

Name	Spec.	Qty
Tapered Spacer Blocks	17" Long	2
Centering/Support Blocks	4 1/2" x 3 1/2" x 1 1/2"	4
Plastic Divider	1/8" x 4 1/2" x 14 1/2"	2
Stuffer Seal	1" x 1 1/2" x 84"	1
Seal	1" x 1 1/2" x 25"	3
Seal	1" x 1 1/2" x 14"	2
Seal	1" x 3/8" x 25"	3
Seal	1" x 3/8" x 14"	2
Seal	1" x 3/4" x 14"	2
Trim Frame(side legs)		2
Trim Frame(top & bottom legs)		2
Ground Wire(green)		1
Toothed Washer for grounding screw		2
Grounding Screw		1
Grille(plastic)		1
Grille Aluminum		1
Nuts(plastic)		4
Screw Washer		4
Screw		4



NOTE:

Save Carton and these Installation Instructions for future reference. The carton is the best way to store unit during winter, or when not in use.

INSTALLATION INSTRUCTIONS

How to Install

1. Identify the wall-sleeve brand for your installation, from the chart below.

Brand	Wall Sleeve Dimensions (inches)		
	Width	Height	Depth
White-Westinghouse Frigidaire Carrier(52F Series) } General Electric/Hotpoint	25½	15¼	16, 17½ or 22
Whirlpool Fedders/Emerson	25⅞	16½	17⅞ or 23
Sears/Kenmore Carrier(51S Series) } Emerson/Fedders	25¾	16⅞	16¾ or 19¾
Friedrich	26¾	15¾	15
	27	16¾	16¾

NOTE: All wall sleeves used to mount the new Air Conditioner must be in sound structural condition and have a rear grille that securely attaches to sleeve, or rear flange that serves as a stop for the Air Conditioner.

CAUTION: When installation is complete, replacement unit **MUST** have a rearward slope as shown.

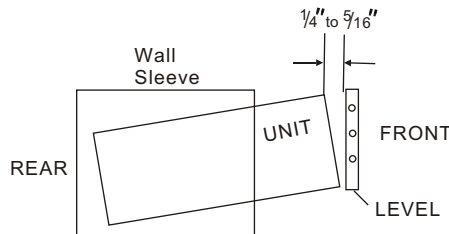

2. Remove old Air Conditioner from wall sleeve and prepare wall sleeve as follows:

- Clean interior (do not disturb seals).
- Wall sleeve must be securely fastened in wall before installing Air Conditioner.
Drive more nails or screws through sleeve, into wall, if needed.
- Repair paint if needed.

3. If not existing, drill a 1/8" clearance hole for grounding screw through left side of wall sleeve, in a clear area about 3 inches maximum back from front edge of sleeve, using grounding screw and toothed washer. Pull loose end of ground wire out front of sleeve, and temporarily bend it down and around lower edge of sleeve. This ground wire will later be attached to frame of air conditioner once it is installed.

Wall sleeve to unit sleeve grounding

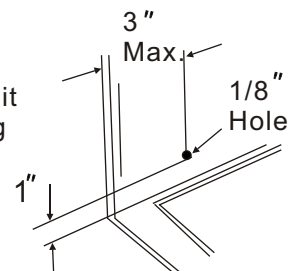

4. Prepare the wall sleeve for installation of the new unit per the following Brand instructions.

#1 Emerson	15" Deep
#2 Fedders	19¾" Deep
#3 Fedders or Friedrich	16¾" Deep
#4 General Electric/Hotpoint	16⅞" Deep
#5 Sears or Carrier(51S Series)	18⅞" Deep
#6 Whirlpool	17⅞" Deep
#7 Whirlpool	23" Deep
#8 White-Westinghouse/ Frigidaire/Carrier(52F Series)	16" + 17½" Deep
#9 White-Westinghouse/Frigidaire	22" Deep

5. Identify your wall sleeve type and follow the instructions for that type in the following pages.

INSTALLATION INSTRUCTIONS

IMPORTANT

- This unit's increased performance characteristics result from having two rear air intakes.
- It is very important that these installation instructions are followed so your unit can operate at maximum efficiency.
- If this is an existing sleeve, and there is an existing rear grille, it needs to be replaced by one that has been shipped with the unit in the accessory kit.

FOR INCREASED EFFICIENCY, UTILIZE THE PROVIDED LOUVERED REAR PANEL

Installation of new grille provided with unit

1. Remove the existing grille.
2. Place the grille included with the new air conditioner towards the rear of the sleeve.
3. Mark through the hole positions.
4. Drill through the sleeves flanges with a 1/8" drill bit.
5. Attached the new grille with self-threading screws and washers.
6. It is **VERY IMPORTANT** that the grille is placed exactly as shown below.
7. Most decorative exterior grilles may be left in place as long as the proper interior air direction grille is installed.

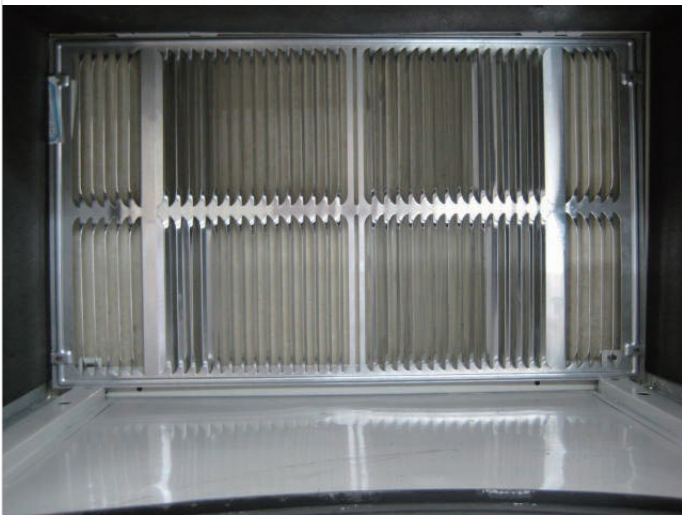

INSTALLATION INSTRUCTIONS

Wall Sleeve Brands:

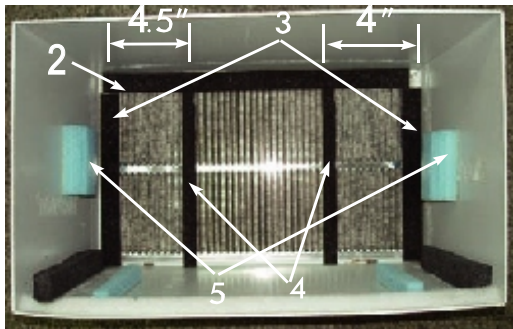
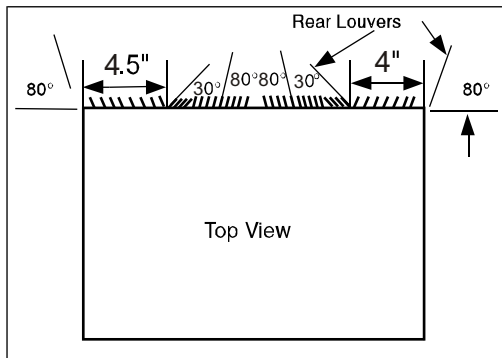

#1 Emerson

15' Deep

1. Remove existing rear grille as shown on Page 6 of this manual and replace with provided louvered rear panel. Install as shown here.

NOTE: You may need to drill holes in flange of existing sleeve to match new rear grille.

2. Attach (1) 1" x 3/8" x 25" long seal in the center at the top of the sleeve. Remove the backing paper and press into position.
3. Attach the (2) 1" x 3/8" x 14" long seals to the left and right sides of the sleeve.
4. Cut (2) 1" x 3/8" x 25" long seals to 14" long, and attach it to the vertical sections of the rear grille as shown.
5. Attach (2) 4 1/2" x 3 1/2" x 1 1/2" centering/support blocks one on each side wall. Place in center of side wall with the tapered end facing the opening.
6. Gently slide unit into sleeve.
7. Before sliding all-the-way back, remove 2nd screw from front on left side of unit.
8. Remove the plastic washer from the screw.
9. Screw and attach the other end of the ground wire to the unit as shown in picture. Make sure that the toothed washer is against the cabinet.
10. Slide the unit completely to the rear to ensure a good seal, making sure the ground wire does not become tangled.
11. Seal & Frame the unit as described on page 17.
12. If you have difficulty with mounting the grill to the sleeve, follow the instructions for direct mounting on Page 16.

INSTALLATION INSTRUCTIONS

Wall Sleeve Brands:

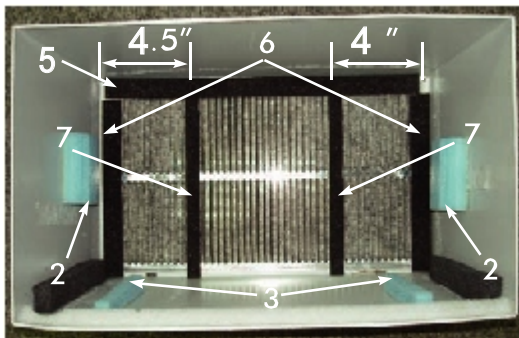
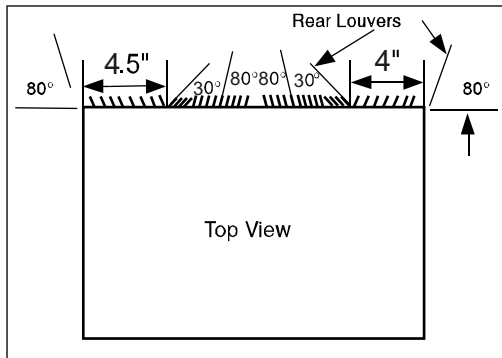

#2 Fedders

19³/₄" Deep

1. Remove existing rear grille as shown on Page 6 of this manual and replace with provided louvered rear panel. Install as shown here.

NOTE: You may need to drill holes in flange of existing sleeve to match new rear grille.

2. Attach (2) 4¹/₂" x 3¹/₂" x 1¹/₂" centering/support blocks one on each side wall. Place in center of side wall with the tapered end facing the opening.
3. Cut (2) 17" Tapered Spacer Blocks as shown below into two pieces.

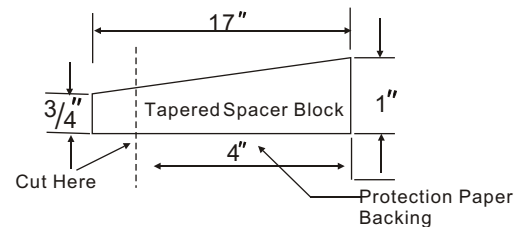

4. The 4" section is placed in front of the rib on base with the tapered end facing the back of the sleeve. The remaining portion will be placed behind the rib again sloping toward the rear of the sleeve. This helps induce a rearward slope on the unit.
5. Attach (1) 1" x 3/8" x 25" long seal in the center at the top of the sleeve. Remove the backing paper and press into position.
6. Attach (2) 1" x 3/8" x 14" seals to the left and right sides of the sleeve.
7. Cut (2) 1" x 3/8" x 25" long seals to 14" long and attach it to the vertical sections of the rear grille as shown.
8. Gently slide unit into sleeve.
9. Before sliding all-the-way back, remove 2nd screw from front on left side of unit.
10. Remove the plastic washer from the screw.
11. Screw and attach the other end of the ground wire to the unit as shown in picture. Make sure that the toothed washer is against the cabinet.
12. Slide the unit completely to the rear to ensure a good seal, making sure the ground wire does not become tangled.
13. Seal & Frame the unit as described on page 17.
14. If you have difficulty with mounting the grill to the sleeve, follow the instructions for direct mounting on Page 16.

INSTALLATION INSTRUCTIONS

Wall Sleeve Brands:

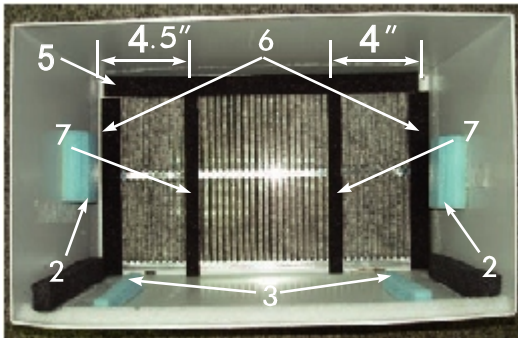
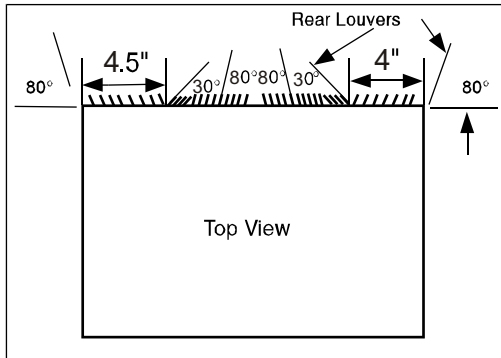

#3 Fedders or Friedrich 16^{3/4}" Deep

1. Remove existing rear grille as shown on Page 6 of this manual and replace with provided louvered rear panel. Install as shown here.

NOTE: You may need to drill holes in flange of existing sleeve to match new rear grille.

2. Attach (2) 4^{1/2}" x 3^{1/2}" x 1^{1/2}" centering/support blocks one on each side wall. Place in center of side wall with the tapered end facing the opening.
3. Cut (2) 17" Tapered Spacer Blocks as shown below into three pieces.

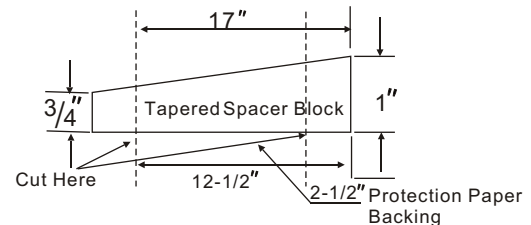

4. The 2^{1/2}" section is placed in front of the rib on base with the tapered end facing the back of the sleeve. Cut the remaining portion to 12^{1/2}" and placed behind the rib again sloping toward the rear of the sleeve. This helps induce a rearward slope on the unit.
5. Attach (1) 1" x 3/8" x 25" long seal in the center at the top of the sleeve. Remove the backing paper and press into position.
6. Attach (2) 1" x 3/8" x 14" seals to the left and right sides of the sleeve.
7. Cut (2) 1" x 3/8" x 25" long seals to 14" long and attach it to the vertical sections of the rear grille as shown.
8. Gently slide unit into sleeve.
9. Before sliding all-the-way back, remove 2nd screw from front on left side of unit.
10. Remove the plastic washer from the screw.
11. Screw and attach the other end of the ground wire to the unit as shown in picture. Make sure that the toothed washer is against the cabinet.
12. Slide the unit completely to the rear to ensure a good seal, making sure the ground wire does not become tangled.
13. Seal & Frame the unit as described on page 17.
14. If you have difficulty with mounting the grill to the sleeve, follow the instructions for direct mounting on Page 16.

INSTALLATION INSTRUCTIONS

Wall Sleeve Brands:

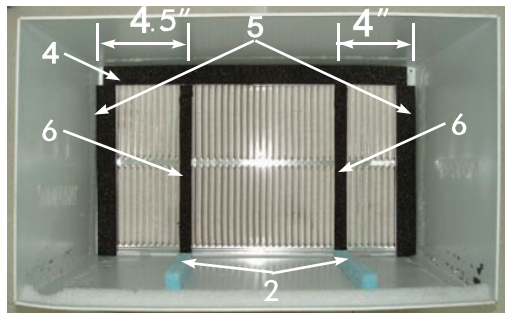
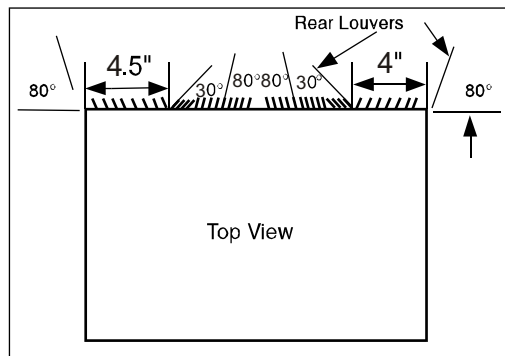

#4 General Electra/Hotpoint 16⁷/₈" Deep

1. Remove existing rear grille as shown on Page 6 of this manual and replace with provided louvered rear panel. Install as shown here.

NOTE: You may need to drill holes in flange of existing sleeve to match new rear grille.

2. Cut (2) 17" Tapered Spacer Blocks as shown below into two pieces.

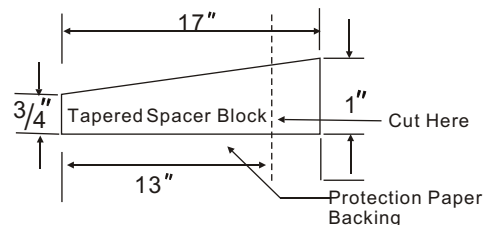

3. Install 13" section as shown with the tapered end $\frac{1}{2}$ from the back of the sleeve. This helps induce a rearward slop on the unit.
4. Attach (1) 1" x 3/8" x 25" long seal in the center at the top of the sleeve. Remove the backing paper and press into position.
5. Attach (2) 1" x 3/8" x 14" seals to the left and right sides of the sleeve.
6. Cut (2) 1" x 3/8" x 25" long seals to 14" long and attach it to the vertical sections of the rear grille as shown.
7. Center unit and gently slide unit into sleeve.
8. Before sliding all-the-way back, remove 2nd screw from front on left side of unit.
9. Remove the plastic washer from the screw.
10. Screw and attach the other end of the ground wire to the unit as shown in picture. Make sure that the toothed washer is against the cabinet.
11. Slide the unit completely to the rear to ensure a good seal, making sure the ground wire does not become tangled.
12. Seal & Frame the unit as described on page 17.
13. If you have difficulty with mounting the grill to the sleeve, follow the instructions for direct mounting on Page 16.

INSTALLATION INSTRUCTIONS

Wall Sleeve Brands:

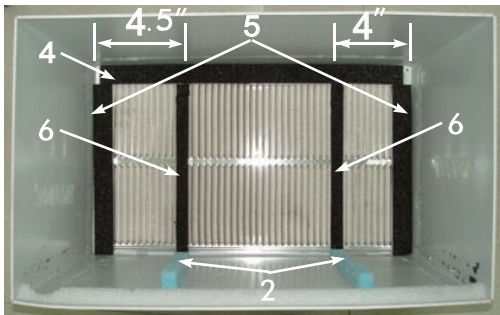
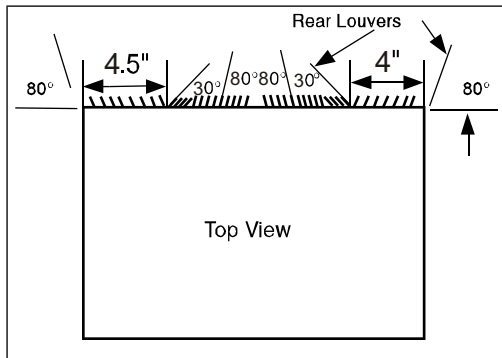

#5 Sears or Carrier 51S Series (18^{5/8}" Deep)

1. Remove existing rear grille as shown on Page 6 of this manual and replace with provided louvered rear panel. Install as shown here.

NOTE: You may need to drill holes in flange of existing sleeve to match new rear grille.

2. Install (2) tapered spacer blocks to the floor of the sleeve as shown. This helps induce a rearward slop on the unit.
3. Install as shown with the tapered end $\frac{1}{2}$ " from the back of the sleeve. This helps induce a rearward slop on the unit.
4. Attach (1) 1" x 3/8" x 25" long seal in the center at the top of the sleeve. Remove the backing paper and press into position.
5. Attach (2) 1" x 3/8" x 14" seals to the left and right sides of the sleeve.
6. Cut (2) 1" x 3/8" x 25" long seals to 14" long and attach it to the vertical sections of the rear grille as shown.
7. Center unit and gently slide unit into sleeve.
8. Before sliding all-the-way back, remove 2nd screw from front on left side of unit.
9. Remove the plastic washer from the screw.
10. Screw and attach the other end of the ground wire to the unit as shown in picture. Make sure that the toothed washer is against the cabinet.
11. Slide the unit completely to the rear to ensure a good seal, making sure the ground wire does not become tangled.
12. Seal & Frame the unit as described on page 17.
13. If you have difficulty with mounting the grill to the sleeve, follow the instructions for direct mounting on Page 16.

INSTALLATION INSTRUCTIONS

Wall Sleeve Brands:

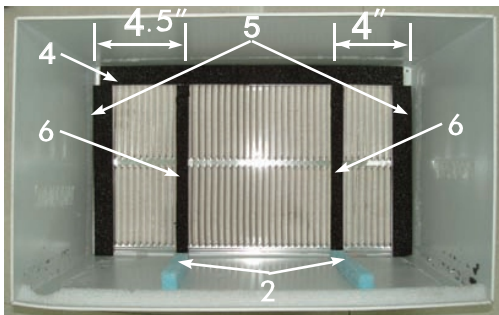
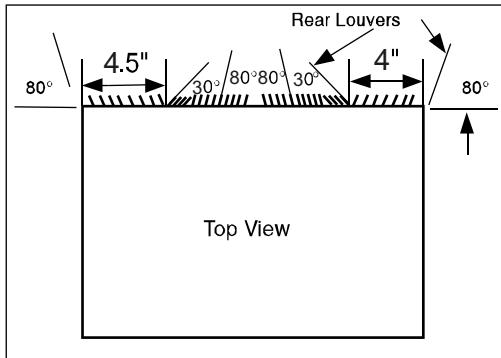

#6 Whirlpool 17¹/₈" Deep

1. Remove existing rear grille as shown on Page 6 of this manual and replace with provided louvered rear panel. Install as shown here.

NOTE: You may need to drill holes in flange of existing sleeve to match new rear grille.

2. Cut (2) 17" Tapered Spacer Blocks as shown below into two pieces.

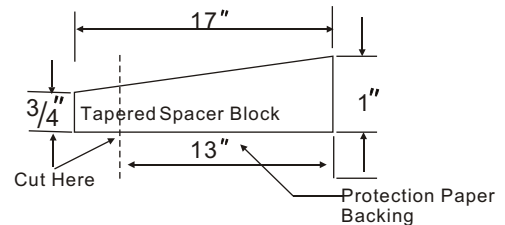

3. Install 13" section to the floor of the sleeve as shown. This helps induce a rearward slop on the unit.
4. Attach (1) 1" x 3/8" x 25" long seal in the center at the top of the sleeve. Remove the backing paper and press into position.
5. Attach (2) 1" x 3/8" x 14" seals to the left and right sides of the sleeve.
6. Cut (2) 1" x 3/8" x 25" long seals to 14" long and attach it to the vertical sections of the rear grille as shown.
7. Center unit and gently slide unit into sleeve.
8. Before sliding all-the-way back, remove 2nd screw from front on left side of unit.
9. Remove the plastic washer from the screw.
10. Screw and attach the other end of the ground wire to the unit as shown in picture. Make sure that the toothed washer is against the cabinet.
11. Slide the unit completely to the rear to ensure a good seal, making sure the ground wire does not become tangled.
12. Seal & Frame the unit as described on page 17.
13. If you have difficulty with mounting the grill to the sleeve, follow the instructions for direct mounting on Page 16.

INSTALLATION INSTRUCTIONS

Wall Sleeve Brands:

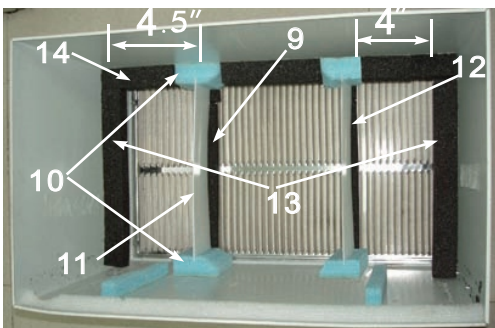
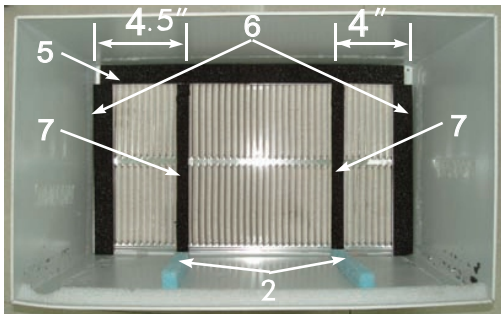
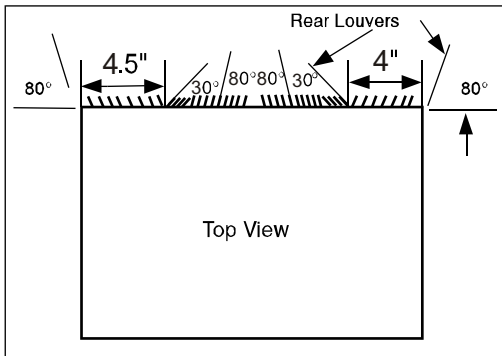

#7 Whirlpool (23" Deep)

1. Remove existing rear grille as shown on Page 6 of this manual and replace with provided louvered rear panel. Install as shown here.

NOTE: You may need to drill holes in flange of existing sleeve to match new rear grille.

Because of the increased unit depth, first try dry fitting using the method described below:

2. Place (2) 1" x 1½" x 14" seals against each side.
3. Gently slide unit in and check if amount extending from the sleeve is sufficient once the trim frame is attached.
4. If position is Ok, remove unit and proceed to the next step. If not go to step 9.
5. Attach (1) 1" x 1½" x 25" long seal in the center at the top of the sleeve. Remove the backing paper and press into position.
6. Attach (2) 1" x 1½" x 14" seals to the left and right sides of the sleeve.
7. Cut (2) 1" x 3/8" x 25" long seals to 14" long and attach to the vertical sections of the grille as shown.
8. Attach the tapered spacer blocks to the floor of the sleeve. Now go to step 15.

Use these next steps if the unit requires extra extension into the room.

9. Attach 1" x 3/4" x 14" long seal over the solid vertical portion of the rear grille.
10. Attach (4) 4½" x 3½" x 1½" foam blocks with the slot overlapping the seal above.
11. Install the divider into the slots of the foam blocks. You may need to trim the length to size.
12. Repeat steps 9-11 for the other vertical shown portion of the grille as shown in the picture.
13. Attach (2) 1" x 1½" x 14" seals along the sides of the sleeve again making sure all seals are flush.
14. Cut the 1" x 1½" x 25" seal to fit the top of the sleeve. The pieces must be fitted flush to the edge of the divider.
15. Center unit and gently slide unit into sleeve.
16. Before sliding all-the-way back, remove 1st screw from front on left side of unit.
17. Remove the plastic washer from the screw.
18. Screw and attach the other end of the ground wire to the unit as shown in picture. Make sure that the toothed washer is against the cabinet.
19. Slide the unit completely to the rear to ensure a good seal, making sure the ground wire does not become tangled.
20. Seal & Frame the unit as described on page 17.
21. If you have difficulty with mounting the grill to the sleeve, follow the instructions for direct mounting on Page 16.

INSTALLATION INSTRUCTIONS

Wall Sleeve Brands:

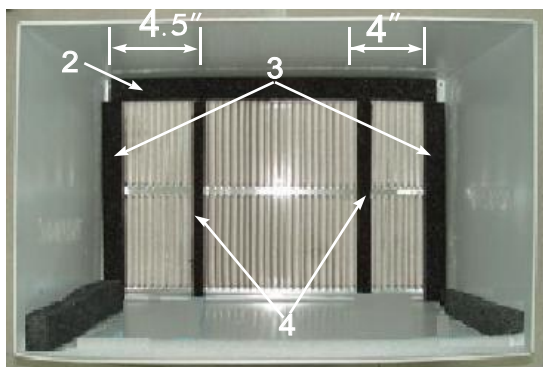
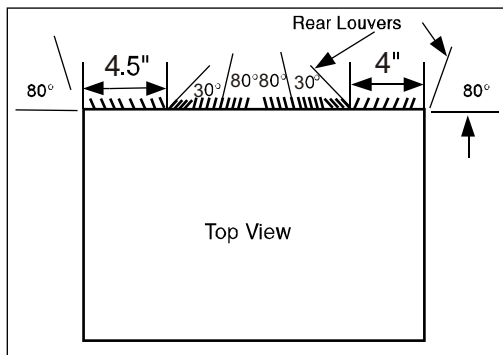

#8 White Westinghouse/Frigidaire/ Carrier 52F Series (16" + 17 1/2" Deep)

1. Remove existing rear grille as shown on Page 6 of this manual and replace with provided louvered rear panel. Install as shown here.

NOTE: You may need to drill holes in flange of existing sleeve to match new rear grille.

2. Attach (1) 1" x 3/8" x 25" long seal in the center at the top of the sleeve. Remove the backing paper and press into position.
3. Attach (2) 1" x 3/8" x 14" seals to the left and right sides of the sleeve.
4. Attach (2) 1" x 3/4" x 14" long seals vertically 4.5" from the left side of the sleeve. Attach the other 1" x 3/4" x 14" long seal 4" from the right side of the sleeve.
5. Center unit and gently slide unit into sleeve.
6. Before sliding all-the-way back, remove 2nd screw from front on left side of unit.
7. Remove the plastic washer from the screw.
8. Screw and attach the other end of the ground wire to the unit as shown in picture. Make sure that the toothed washer is against the cabinet.
9. Slide the unit completely to the rear to ensure a good seal, making sure the ground wire does not become tangled.
10. Seal & Frame the unit as described on page 17.
11. If you have difficulty with mounting the grill to the sleeve, follow the instructions for direct mounting on Page 16.

INSTALLATION INSTRUCTIONS

Wall Sleeve Brands:

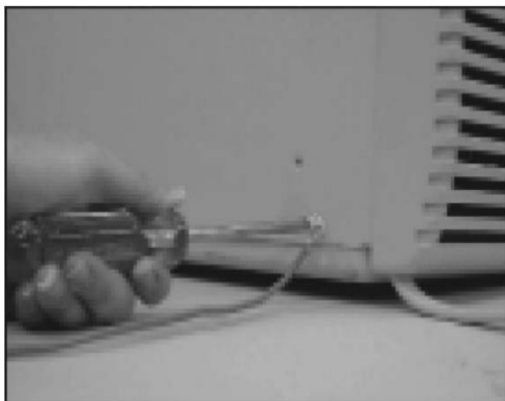
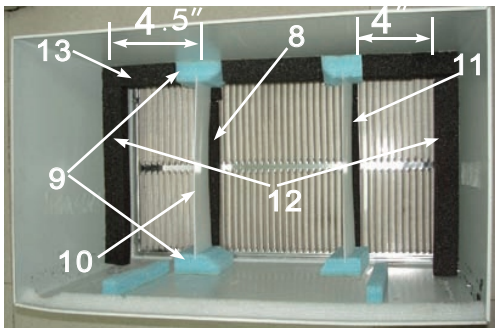
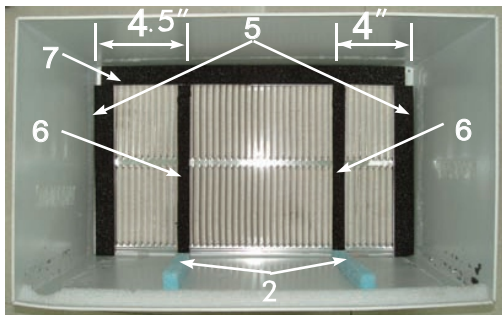
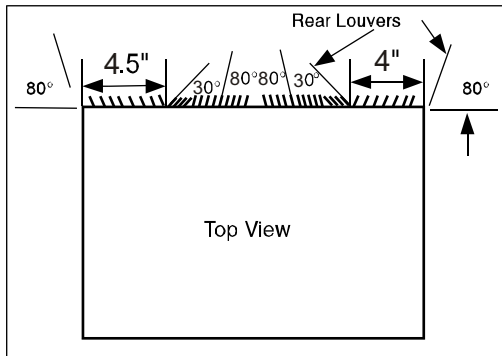

#9 White Westinghouse or Frigidaire (22' Deep)

1. Remove existing rear grille as shown on Page 6 of this manual and replace with provided louvered rear panel. Install as shown here.

NOTE: You may need to drill holes in flange of existing sleeve to match new rear grille.

- Because of the increased unit depth, first try dry fitting using the method described below:**
2. Place (2) 1 " x1½" x14" seals against each side.
 3. Gently slide unit in and check if amount extending from the sleeve is sufficient once the trim frame is attached.
 4. If position is Ok, remove unit and proceed to the next step. If not go to step 8.
 5. Attach (1)1 " x1½" x15" long seal to the left and right sides of the sleeve.
 6. Cut (1) 1" x1½" x25" long seal to 14" long and attach it vertically to the rear grill 4.5" from the left side ,repeat and attach 4" from the right side.
 7. Attach(1) 1 " x1½" x25" long seal in the center at the top of the sleeve.Remove the backing paper and press into position.Proceed to step 14.

Use these next steps if the unit requires extra extension into the room.

8. Attach 1" x¾" x14" long seal over the solid vertical portion of the rear grille.
9. Attach (4) 4½" x3½" x1½" foam blocks with the slot overlapping the seal above.
10. Install the divider into the slots of the foam blocks. You may need to trim the length to size.
11. Repeat steps 8-10 for the other vertical shown portion of the grille as shown in the picture.
12. Attach (2) 1" x1½" x14" seals along the sides of the sleeve again making sure all seals are flush.
13. Cut the 1" x1½" x25" seal to fit the top of the sleeve. The pieces must be fitted flush to the edge of the divider.
14. Center unit and gently slide unit into sleeve.
15. Before sliding all-the-way back, remove 1st screw from front on left side of unit.
16. Remove the plastic washer from the screw.
17. Screw and attach the other end of the ground wire to the unit as shown in picture. Make sure that the toothed washer is against the cabinet.
18. Slide the unit completely to the rear to ensure a good seal, making sure the ground wire does not become tangled.
19. Seal & Frame the unit as described on page 17.
20. If you have difficulty with mounting the grill to the sleeve, follow the instructions for direct mounting on Page 16.

INSTALLATION INSTRUCTIONS

Direct Unit Mounting:

The previous directions are the preferable way to mount the new rear grill. The unit's performance is slightly better and the possibility of draughts is reduced. As a last resort, direct mounting of the grille to the unit can be considered.

Note: The grille must be installed prior to inserting the unit into the sleeve.

1. Attach the 2 seal pieces (1"X3/8"X14") as shown in Fig. 1.
2. Position the grille over the rear of the unit making sure that:
 - a. The double set of screw holes are at the bottom.
 - b. The fins of the grill are pointed away from the unit.
3. Align the top of the grille with the top of the unit. The overhang on each side is equal.
4. If the unit has not been pre-drilled (some models), carefully drill 4-1/8" holes through the grille and into the side flange of the unit approximately 1 1/2" to 2" from the top and bottom as in Fig. 2, 3.
(Be careful not to drill into the copper heat exchanger coils.)
5. Install 4 - #8 self tapping screws to affix the grille to the unit.
6. Insert the unit into the sleeve.

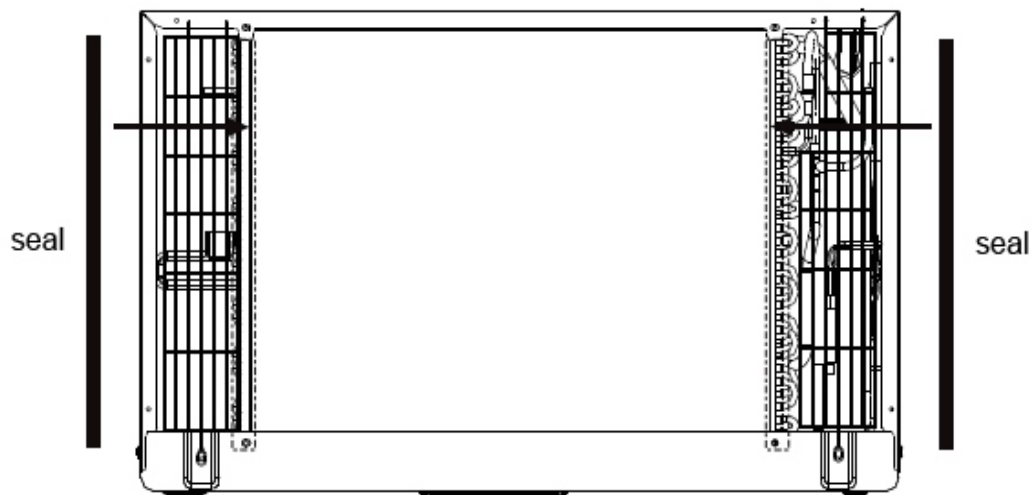

Fig. 1

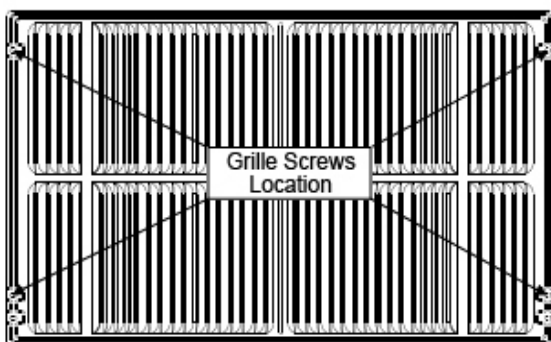

Fig. 2

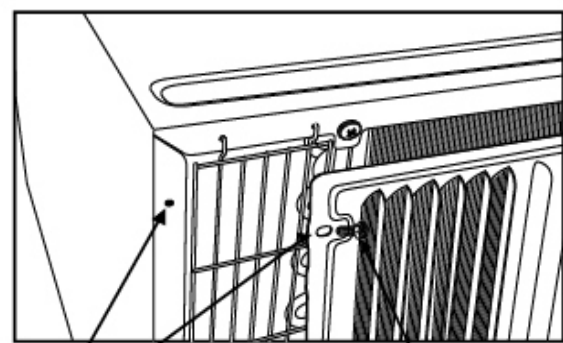

Fig. 3

1/8 Hole
Grille &
Flange

8 Screw

INSTALLATION INSTRUCTIONS

FINISHING INSTALLATION:

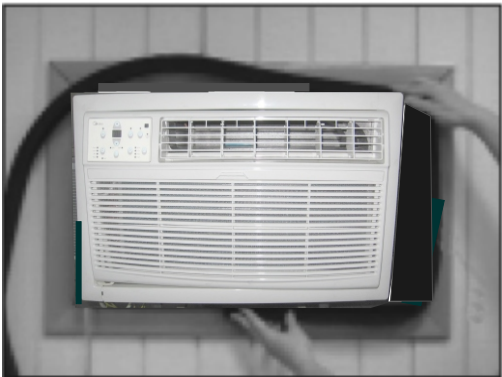

1. Install the 1"x1½"x84" long stuffer-seal between the wall-sleeve and the unit. A flat-bladed screwdriver or putty knife is recommended.



2. Assemble the trim frame by inserting top and bottom pieces into side pieces and snapping into place.

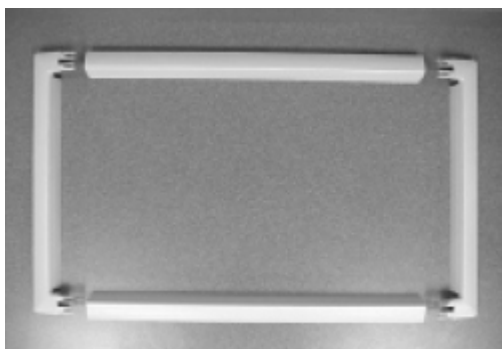

3. Pull cord through trim frame then slide over unit until flush with wall.

NORMAL SOUNDS

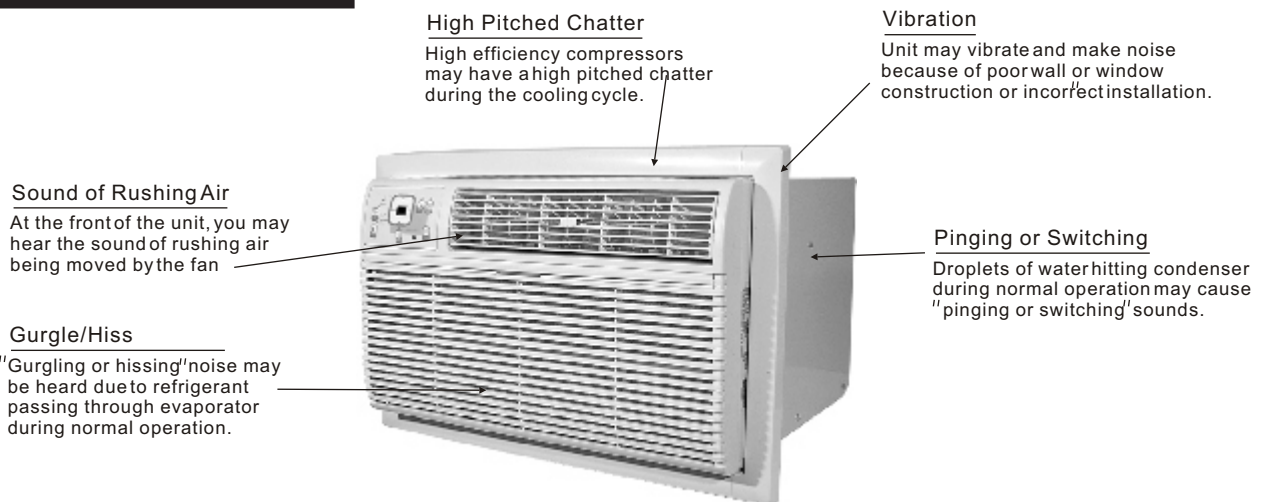

NOTE:

All the illustrations in this manual are for explanation purpose only. Your air conditioner may be slightly different. The actual shape shall prevail.

AIR CONDITIONER FEATURES

ELECTRONIC CONTROL OPERATING INSTRUCTIONS

Before you begin, thoroughly familiarize yourself with the control panel as shown below and all its functions, then follow the symbol for the functions you desire. **The unit can be controlled by the unit control alone or with the remote.**

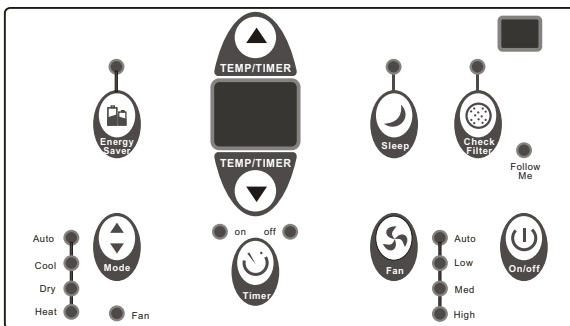

(Electric Heating Models)

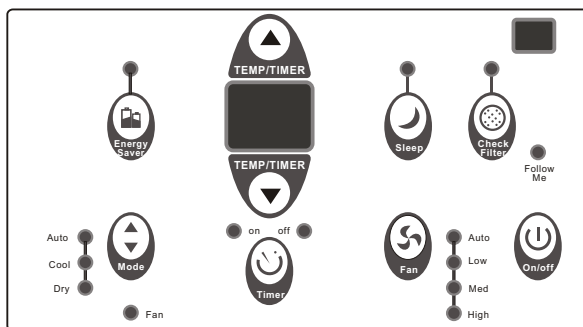

(Cooling Only Models)

TO TURN UNIT ON OR OFF:

Press **⏻ ON/OFF** button to turn unit on or off.

NOTE: The unit will initiate automatically the Energy Saver function under Cool, Dry, Auto (only Auto-Cooling and Auto-Fan) modes.

TO CHANGE TEMPERATURE SETTING:

Press **▲ / ▼ UP/DOWN** button to change temperature setting.

NOTE: Press or hold either UP (▲) or DOWN (▼) button until the desired temperature is seen on the display. This temperature will be automatically maintained anywhere between 62°F (17°C) and 86°F (30°C). If you want the display to read the actual room temperature, see "To Operate on Fan Only" section.

AIR CONDITIONER FEATURES

TO ADJUST FAN SPEEDS:

Press  to select the Fan Speed in four steps-Auto, Low, Med or High. Each time the button is pressed, the fan speed mode is shifted. For some models, the fan speed can not be adjusted under HEAT mode. On Dry mode, the fan speed is controlled at Low automatically.

SLEEP FEATURE:

Press  Sleep button to initiate the sleep mode. In this mode the selected temperature will increase (cooling) or decrease (heating) by 2°F/1(or 2)°C 30 minutes after the mode is selected. The temperature will then increase (cooling) or decrease (heating) by another 2°F/1(or 2)°C after an additional 30 minutes. This new temperature will be maintained for 6 hours before it returns to the originally selected temperature. This ends the Sleep mode and the unit will continue to operate as originally programmed. The Sleep mode program can be cancelled at any time during operation by pressing the Sleep button again.

CHECK FILTER FEATURE:

Press  Check filter button to initiate this feature. This feature is a reminder to clean the Air Filter for more efficient operation. The LED (light) will illuminate after 250 hours of operation. To reset after cleaning the filter, press the Check Filter button and the light will go off.

ENERGY SAVER FEATURE:

Press  Energy saver button to initiate this function. This function is available on COOL, DRY, AUTO (only AUTO-COOLING and AUTO-FAN) modes. The fan will continue to run for 3 minutes after the compressor shuts off. The fan then cycles on for 2 minutes at 10 minute intervals until the room temperature is above the set temperature, at which time the compressor turns back on and Cooling Starts.

FOLLOW ME FEATURE:(on some models)



This feature can be activated from the remote control ONLY. The remote control serves as a remote thermostat allowing for the precise temperature control at its location.

To activate the Follow Me feature, point the remote control towards the unit and press the Follow Me button. The remote display is actual temperature at its location. The remote control will send this signal to the air conditioner every 3 minutes interval until press the Follow Me button again. If the unit does not receive the Follow Me signal during any 7 minutes interval, the unit will beep to indicate the Follow Me mode has ended.

TO SELECT THE OPERATING MODE:

To choose operating mode, press  Mode button. Each time you press the button, a mode is selected in a sequence that goes from Auto, Cool, Dry, heat (cooling only models without) and Fan. The indicator light beside will be illuminated and remained on once the mode is selected.

The unit will initiate automatically the Energy Saver function under Cool, Dry, Auto (only Auto-Cooling and Auto-Fan) modes.

To operate on Auto feature:

- When you set the air conditioner in AUTO mode, it will automatically select cooling, heating (cooling only models without), or fan only operation depending on what temperature you have selected and the room temperature.
- The air conditioner will control room temperature automatically round the temperature point set by you.
- In this mode, the fan speed cannot be adjusted, it starts automatically at a speed according to the room temperature.

To operate on Fan Only:

- Use this function only when cooling is not desired, such as for room air circulation or to exhaust stale air (on some models). (Remember to open the vent during this function, but keep it closed during cooling for maximum cooling efficiency.) You can choose any fan speed you prefer.
- During this function, the display will show the actual room temperature, not the set temperature as in the cooling mode.
- In Fan only mode, the temperature is not adjusted.

To operate on Dry mode:

- In this mode, the air conditioner will generally operate in the form of a dehumidifier. Since the conditioned space is a closed or sealed area, some degree of cooling will continue.

TIMER: AUTO START/STOP FEATURE:

- When the unit is on or off, first press  Timer button, the TIMER ON indicator light illuminates. It indicates the Auto Start program is initiated.
- When the time of TIMER ON is displayed, press the Timer button again, the TIMER OFF indicator light illuminates. It indicates the Auto Stop program is initiated.
- Press or hold the UP or DOWN button to change the Auto time by 0.5 hour increments, up to 10 hours, then at 1 hour increments up to 24 hours. The control will count down the time remaining until start.
- The selected time will register in 5 seconds, and the system will automatically revert back to display the previous temperature setting or room temperature when the unit is on. (when the unit is off, there is no display.)
- Turning the unit ON or OFF at any time or adjusting the timer setting to 0.0 will cancel the Auto Start/Stop timed program.

AIR CONDITIONER FEATURES

DISPLAYS:

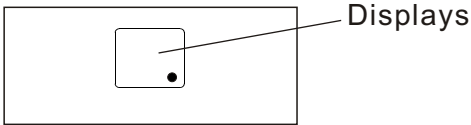

DISPLAYS:

Shows the set temperature in " °C" or " °F" and the Auto-timer settings. While on Fan only mode, it shows the room temperature.

Error codes:

AS-Room temperature sensor error-Unplug the unit and plug it back in.If error repeats, call for service.
NOTE:In Fan only mode,it will display "LO" or "HI".

- -Evaporator temperature sensor error-Unplug the unit and plug it back in.If error repeats, call for service.

NOTE: "•" is displayed as shown in the left picture.

HS -Electric heating sensor error-Unplug the unit and plug it back in.If error repeats, call for service.

NOTE:

If the unit breaks off unexpectedly due to the power cut, it will restart with the previous function setting automatically when the power resumes.

ADDITIONAL THINGS YOU SHOULD KNOW

Now that you have mastered the operating procedure, here are more features in your control that you should become familiar with.

- The Cool circuit has an automatic 3 minute time delayed start if the unit is turned off and on quickly. This prevents overheating of the compressor and possible circuit breaker tripping. The fan will continue to run during this time.
- The control is capable of displaying temperature in degrees Fahrenheit or degrees Celsius. To convert from one to the other, press and hold the Left and Right Temp/Timer buttons at the same time, for 3 seconds.

Air Directional Louvers

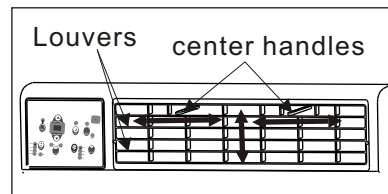

Air Direction(4-way)

Air directional louvers control air flow direction. Your air conditioner has the 4-way directional system described below. The louvers will allow you to direct the air flow Up or Horizontal, and Left or Right throughout the room as needed. Use the center handles to adjust the air directional louvers side-to-side until the desired Left or Right direction is obtained. Pivot horizontal louvers with your fingertips until the desired Up or Horizontal direction is obtained. There are a total of 4 possible air directional orientations available with this system.

CARE AND CLEANING

Air Filter Cleaning

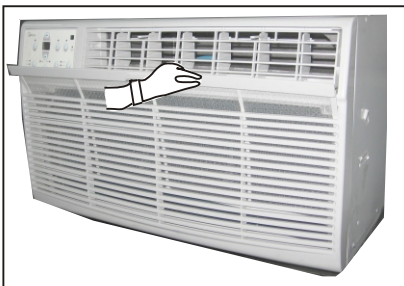

The air filter should be checked at least once a month to see if cleaning is necessary. Trapped particles in the filter can build up and cause an accumulation of frost on the cooling coils.

CAUTION

Clean your air conditioner occasionally to keep it looking new. **Be sure to unplug the unit before cleaning to prevent shock or fire hazards.**

CARE AND CLEANING

Air Filter Cleaning

- Take the filter by the center and pull up and out.
- Wash the filter using liquid dishwashing detergent and warm water. Rinse filter thoroughly. Gently shake excess water from the filter. Be sure the filter is thoroughly dry before replacing. Or, instead of washing you may vacuum the filter clean.

Note: Never use hot water over 40°C(104°F) to clean the air filter. Never attempt to operate the unit without the air filter.

Winter Storage

If you plan to store the air conditioner during the winter, remove it carefully from the window according to the installation instructions. Cover it with plastic or return it to the original carton.

Energy Saving Note:

In order to reach the maximum energy saving and comfort, it is recommended to use a cover to insulate the unit when the unit is not in use. The recommended size for the unit is 24.4"x14.8"x2.2"(WxHxD).

Cabinet Cleaning

- Be sure to unplug the air conditioner to prevent shock or fire hazard. The cabinet and front may be dusted with an oil-free cloth or washed with a cloth dampened in a solution of warm water and mild liquid dishwashing detergent. Rinse thoroughly and wipe dry.
- Never use harsh cleaners, wax or polish on the cabinet front.
- Be sure to wring excess water from the cloth before wiping around the controls. Excess water in or around the controls may cause damage to the air conditioner.
- Plug in air conditioner.

TROUBLESHOOTING TIPS

Before calling for service, review this list. It may save your time and expense. This list includes common occurrences that are not the result of defective workman-ship or materials in this appliance.

Problem	Solution
Air conditioner does not start	<i>Wall plug disconnected. Push plug firmly into wall outlet.</i>
	<i>House fuse blown or circuit breaker tripped. Replace fuse with time delay type or reset circuit breaker.</i>
	<i>Plug Current Device Tripped. Press the RESET button.</i>
	<i>Power is OFF. Turn power ON.</i>
Air from unit does not feel cold enough	<i>Room temperature below 62°F(17°C). Cooling may not occur until room temperature rises above 62°F(17°C).</i>
	<i>Temperature sensing behind air filter element touching cold coil. Keep it from the cold coil.</i>
	<i>Set to a Lower temperature.</i>
	<i>Compressor stopped when changing modes. Wait for 3 minutes after set to the COOL mode.</i>
Air conditioner cooling, but room is too warm- ice forming on cooling coil behind decorative front.	<i>Outdoor temperature below 64°F(18°C). To defrost the coil, set FAN ONLY mode.</i>
	<i>Air filter may be dirty. Clean filter. Refer to Care and Cleaning section. To defrost, set to FAN ONLY mode.</i>
	<i>Thermostat set too cold for night-time cooling. To defrost the coil, set to FAN ONLY mode. Then, set temperature to a Higher setting.</i>

TROUBLESHOOTING TIPS

Problem	Solution
Air conditioner cooling, but room is too warm- NO ice forming on cooling coil behind decorative front.	<i>Dirty air filter- air restricted. Clean air filter. Refer to Care and Cleaning section.</i>
	<i>Temperature is set too High, set temperature to a Lower setting.</i>
	<i>Air directional louvers positioned improperly. Position louvers for better air distribution.</i>
	<i>Front of units is blocked by drapes, blinds, furniture, etc. - restricts air distribution. Clear blockage in front of unit.</i>
	<i>Doors, windows, registers, etc. Open- cold air escapes. Close doors, windows, registers.</i>
	<i>Unit recently turned on in hot room. Allow additional time to remove " Stored heat" from walls, ceiling, floor and furniture.</i>
Air conditioner turns on and off rapidly	<i>Dirty air filter- air restricted. Clean air filter.</i>
	<i>Outside temperature extremely hot. Set FAN speed to a Higher setting to bring air past cooling coils more frequently.</i>
Noise when unit is cooling	<i>Air movement sound. This is normal . If too loud, set to a slower FAN setting.</i>
	<i>Window vibration - poor installation. Refer to installation instructions or check with installer.</i>
Water dripping INSIDE when unit is cooling.	<i>Improper installation. Tilt air conditioner slightly to the outside to allow water drainage. Refer to installation instructions - check with installer.</i>
Water dripping OUTSIDE when unit is cooling.	<i>Unit removing large quantity of moisture from humid room. This is normal during excessively humid days.</i>
Remote Sensing Deactivating Prematurely (some models)	<i>Remote control not located within range. Place remote control within 20 feet & 180°, radius of the front of the unit.</i>
	<i>Remote control signal obstructed. Remove obstruction.</i>
Room too cold	<i>Set temperature too low. Increase set temperature.</i>

The design and specifications are subject to change without prior notice for product improvement. Consult with the sales agency or manufacturer for details.

CW021IU-B(TTW)X(XD)NY
16120300000260
20151116